





# SELENE

---

Inspired by the Greek goddess of the moon, Selene illustrates our quest for enlightenment as we journey through the phases of life. Our Selene collection features illuminated hand cast glass in Full Moon White and New Moon Clear, suspended on linear sculptural forms. Let the magic of Selene bring light into your life!

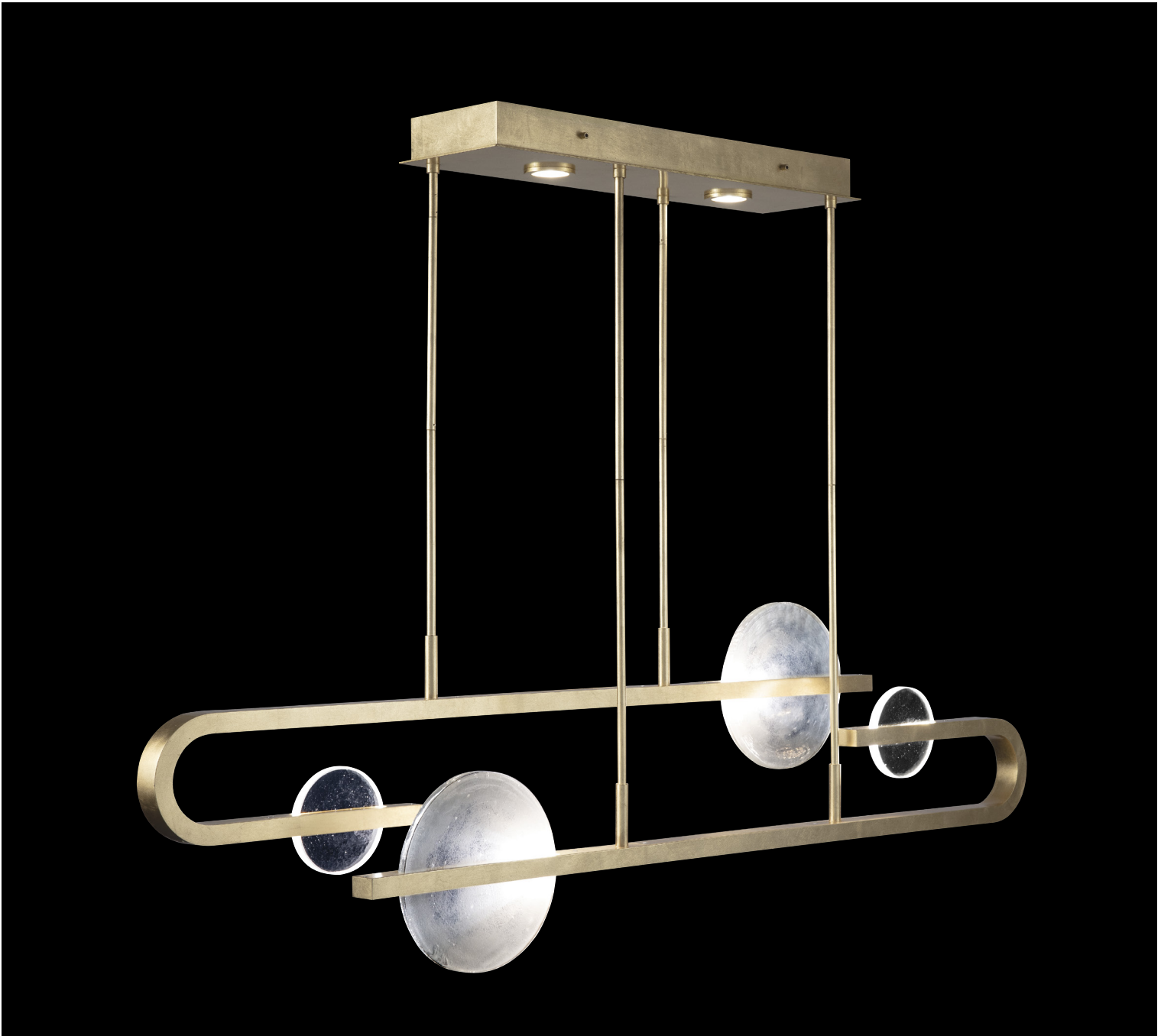

## 65" LINEAR PENDANT

**Model #**  
922840-5 Standard Soft Gold Leaf

**Dimensions**  
H 20" (50 cm) W 65" (165 cm) D 8.5" (22 cm)  
Min Ht: 25.5" (65 cm) Max Ht: 88" (224 cm)

**Electrical**  
Canopy: US/INTL: MR16, GU10, 10w max (Qty. 2)  
Fixture: US/INTL: Integrated LED, 12w max (Qty. 6)  
Total Lumens: 7300  
Upper & lower lights are wired independently for single or dual light control.  
Not suitable for vaulted ceilings. Rods come in connectible segments for customizable length: (four) 3", (four) 6", (eight) 12", (eight) 18"

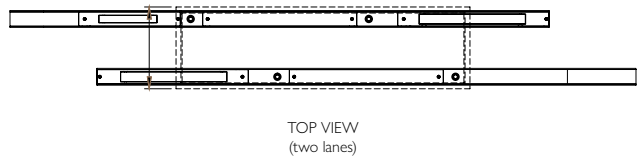

TOP VIEW  
(two lanes)

**FINISH OPTIONS** Also available in Standard Bronze. See page 402 of our comprehensive 2023 Catalog.

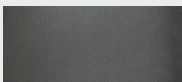

Standard Black Iron  
(-1)



Standard Gold Leaf  
(-3)



Standard Silver Leaf  
(-4)

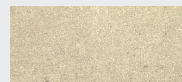

Standard Soft Gold Leaf  
(-5)



## 56.5" LINEAR PENDANT

### Model #

922740-1 Standard Black Iron

### Dimensions

H 53.5" (136 cm) W 56.5" (144 cm) D 10" (25 cm)  
 Min Ht: 45.5" (116 cm) Max Ht: 111.5" (283 cm)

### Electrical

Canopy: US/INTL: MR16, GU10, 10w max (Qty. 2)  
 Fixture: US/INTL: Integrated LED, 12w max (Qty. 12)  
 Total Lumens: 9350

Upper & lower lights are wired independently for single or dual light control.  
 Not suitable for vaulted ceilings. Rods come in connectible segments for customizable length: (eight) 3", (eight) 6", (twenty-six) 12", (six) 18"

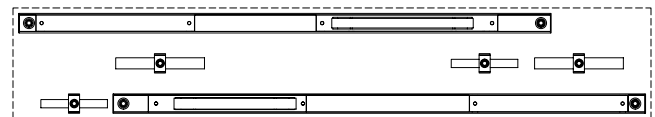

TOP VIEW  
(three lanes)

Linear pendants are only available in a mix of New Moon and Full Moon Clear; studio glass. For alternate glass options contact Customer Service or your Territory Manager.

For adjustability information see page 10 for specific ceiling height.

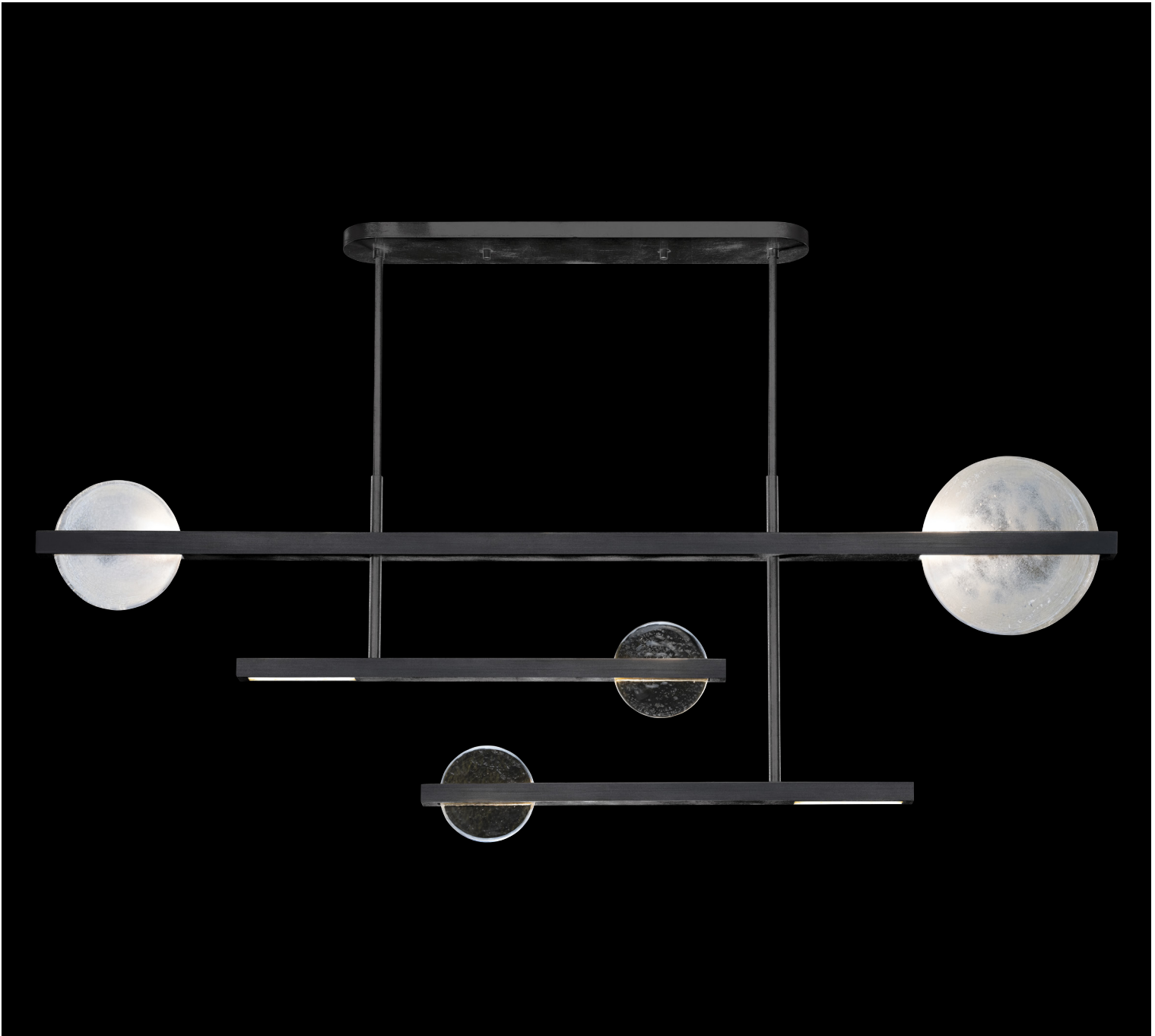

## 66.5" LINEAR PENDANT

**Model #**  
921240-1 Standard Black Iron

**Dimensions**  
H 23.75" (60 cm) W 66.5" (169 cm) D 4.5" (11 cm)  
Min Ht: 26" (66 cm) Max Ht: 92" (234 cm)

**Electrical**  
US/INTL: Integrated LED, 4/12w max, 3000K (Qty. 6)  
Total Lumens: 6400  
Not suitable for vaulted ceilings. Rods come in connectible segments  
for customizable length: (two) 18", (two) 12", (one) 6", (one) 3"

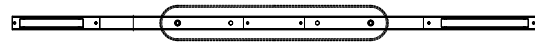

TOP VIEW  
one lane

**FINISH OPTIONS** Also available in Standard Bronze. See page 402 of our comprehensive 2023 Catalog.

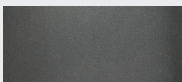

Standard Black Iron  
(-1)



Standard Gold Leaf  
(-3)



Standard Silver Leaf  
(-4)

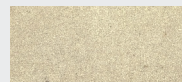

Standard Soft Gold Leaf  
(-5)



## 16" ROUND PENDANT

### Model #

922240-4 Standard Silver Leaf/New Moon Clear Studio Glass

### Dimensions

H 24.75" (63 cm) W 16" (41 cm)  
Min Ht: 29" (75 cm) Max Ht: 95" (242 cm)

### Electrical

US/INTL: Integrated LED, 12w max, 3000K (Qty. 6)  
Total Lumens: 6000  
Not suitable for vaulted ceilings.  
Rods come in connectible segments for customizable length:  
(two) 18", (two) 12", (one) 6", (one) 3"

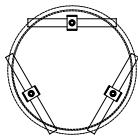

## 11" ROUND PENDANT

### Model #

922140-5 Standard Soft Gold Leaf/Full Moon Studio Glass

### Dimensions

H 24.75" (63 cm) W 11" (28 cm)  
Min Ht: 28" (72 cm) Max Ht: 94" (240 cm)

### Electrical

US/INTL: Integrated LED, 12w max, 3000K (Qty. 2)  
Total Lumens: 2000  
Not suitable for vaulted ceilings.  
Rods come in connectible segments for customizable length:  
(two) 18", (two) 12", (one) 6", (one) 3"

**GLASS OPTIONS** Round pendants feature choice of clear (New Moon Clear) or white (Full Moon) glass option:



New Moon Clear  
Studio Glass

16" Round Pendant (3-drops):

922240-x (New Moon Clear Studio Glass)  
922640-x (Full Moon Studio Glass)



Full Moon  
Studio Glass

11" Round Pendant (1-drop):

921340-x (New Moon Clear Studio Glass)  
922140-x (Full Moon Studio Glass)



**44" SCONCE**

Left side facing.  
Also available right side facing: MODEL #921750-x

**Model #**  
920650-1 Standard Black Iron

**Dimensions**  
H 44" (112 cm) W 12.75" (32 cm) D 3.5" (9 cm)  
ADA Compliant

**Electrical**  
US/INTL: Integrated LED, 10w max, 3000K (Qty. 2)  
Total Lumens: 2000

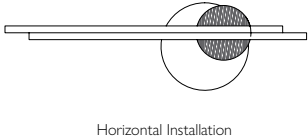

**36" SCONCE**

Left side facing.  
Also available right side facing: MODEL #923050-x

**Model #**  
922950-5 Standard Soft Gold Leaf

**Dimensions**  
H 36" (91 cm) W 14.5" (37 cm) D 3" (8 cm)  
ADA Compliant

**Electrical**  
US/INTL: Integrated LED, 10w max, 3000K (Qty. 2)  
Total Lumens: 2000

**FINISH OPTIONS** Also available in Standard Bronze. See page 402 of our comprehensive 2023 Catalog.

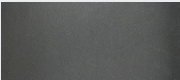

Standard Black Iron (-1)

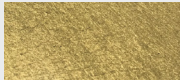

Standard Gold Leaf (-3)



Standard Silver Leaf (-4)



Standard Soft Gold Leaf (-5)

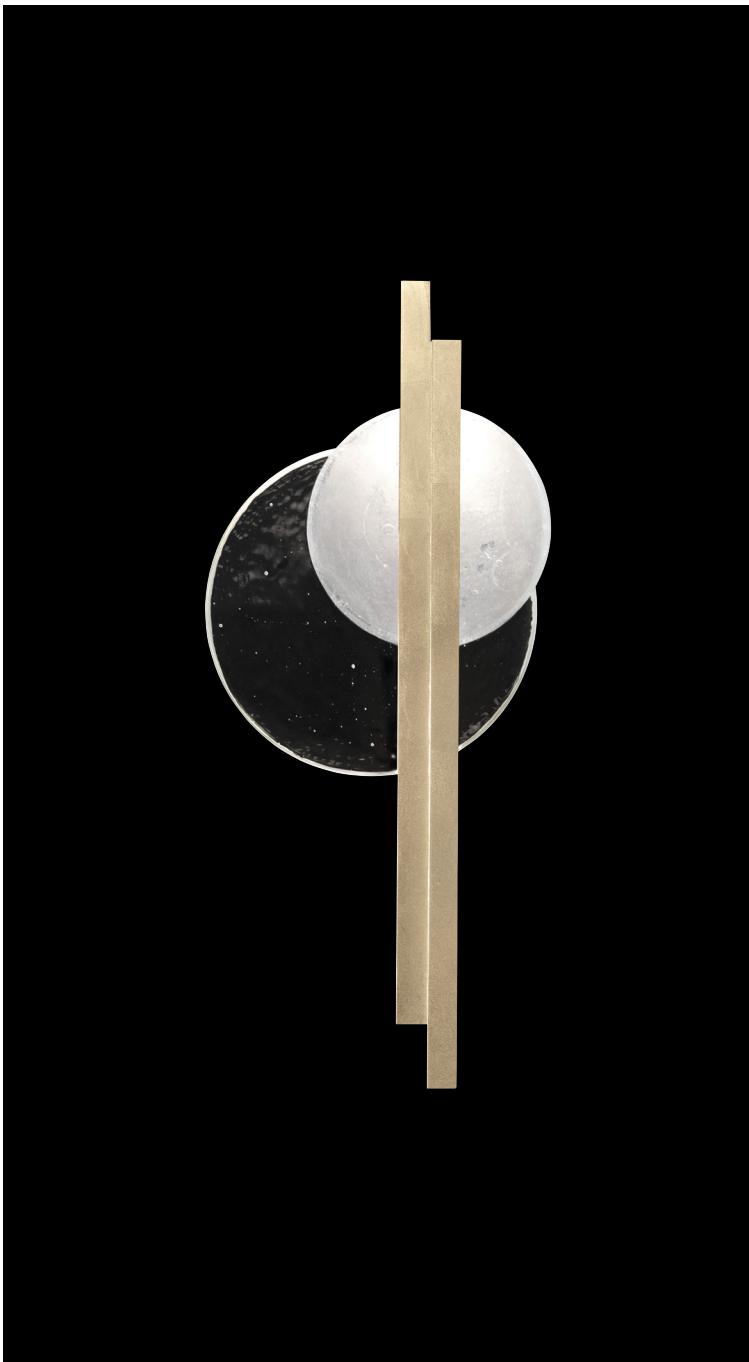

## 26" SCONCE

Left side facing.

Also available right side facing: MODEL #921650-x

### Model #

920550-3 Standard Gold

### Dimensions

H 26" (66 cm) W 11.5" (29 cm) D 3.5" (9 cm)

ADA Compliant

### Electrical

US/INTL: Integrated LED, 12w max, 3000K (Qty. 2)

Total Lumens: 2000

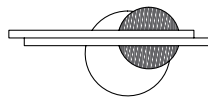

Horizontal Installation

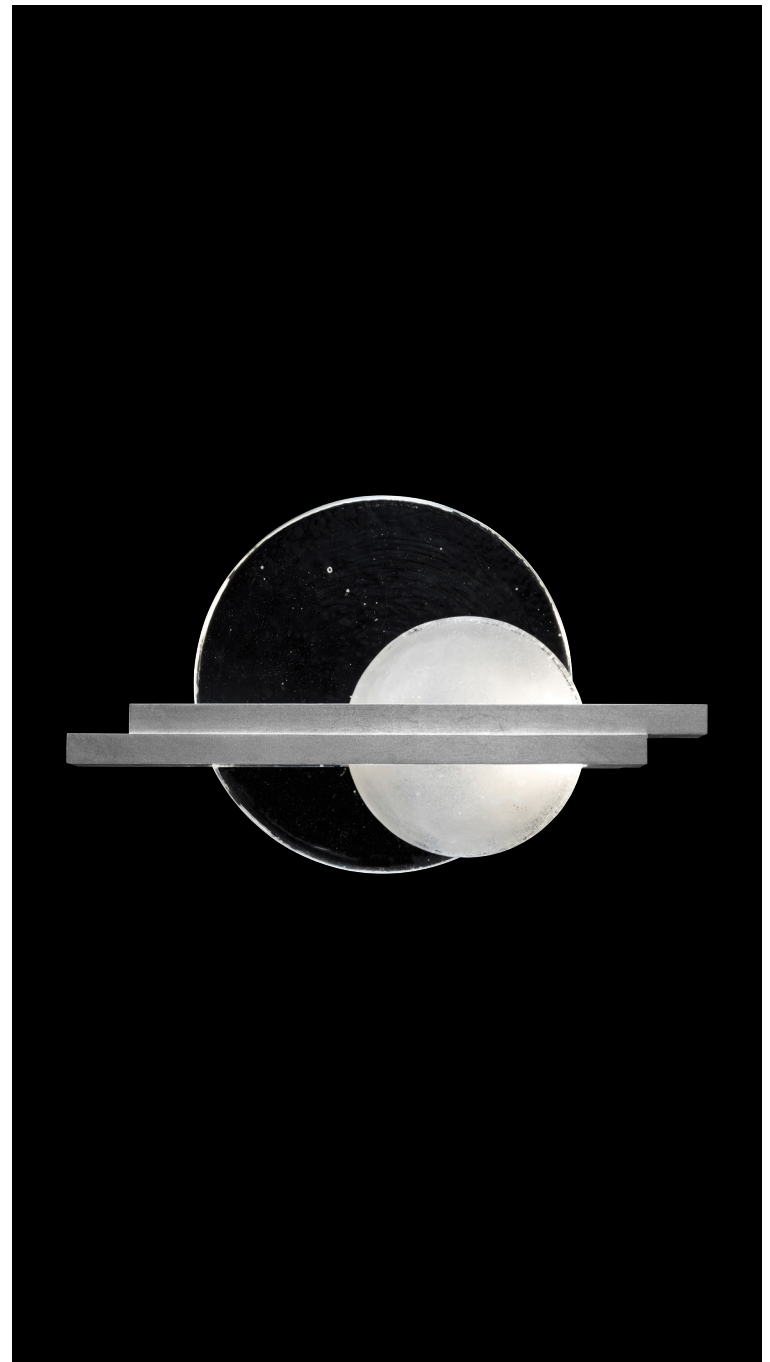

## 12.75" SCONCE

Left side facing.

Also available right side facing: MODEL #922450-x

### Model #

922350-4 Standard Silver Leaf

### Dimensions

H 12.75" (32 cm) W 21" (53 cm) D 3.75" (10 cm)

ADA Compliant

### Electrical

US/INTL: Integrated LED, 12w max, 3000K (Qty. 2)

Total Lumens: 2000

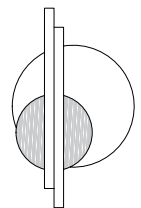

Vertical Installation

Sconces can be installed horizontally or vertically, except Model No. 923050 and 922950.



# SELENE'S ADJUSTABILITY

Selene's linear pendants come with multiple rods allowing for ceiling height adjustability.

Model No. 922740 includes: (8) 3", (8) 6", (26) 12", (6) 18"



Practical threaded rods are the system Selene uses to attach each drop section.

For assistance on alternate rod lengths and other installation variations please call our Customer Service department.

## DID YOU KNOW?

Model No. 922740 has 6 independent adjustable height "pendants" letting you create a true piece of sculptural lighting art.

**8' CEILING INSTALLATION**  
rods used: (2) 3", (4) 6", (4) 12", (4) 18"

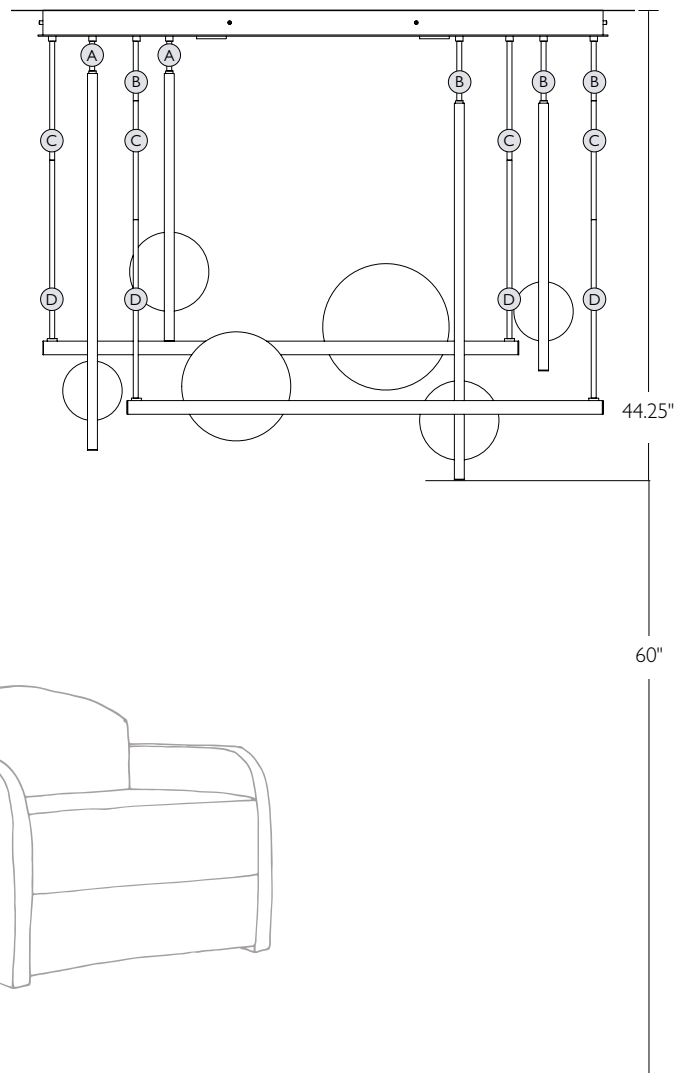

SELENE ROD LEGEND

A	3"
B	6"
C	12"
D	18"

10' CEILING INSTALLATION  
rods used: (7) 3", (12) 13"

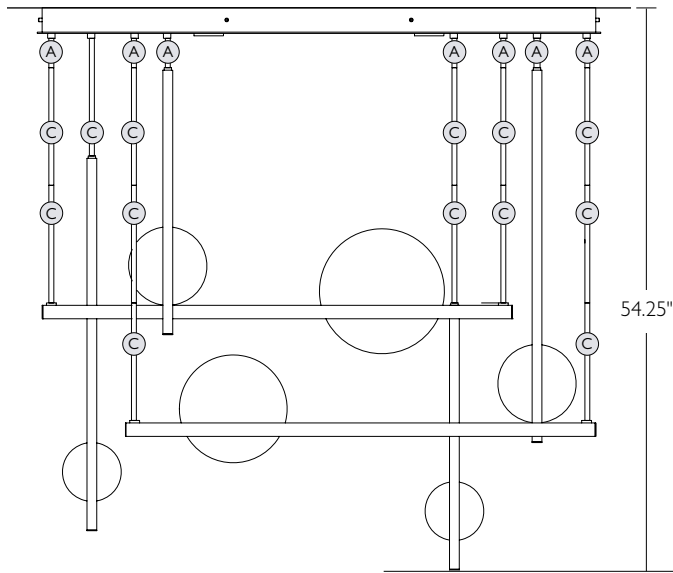

12' CEILING INSTALLATION  
rods used: (26) 12", (2) 18"

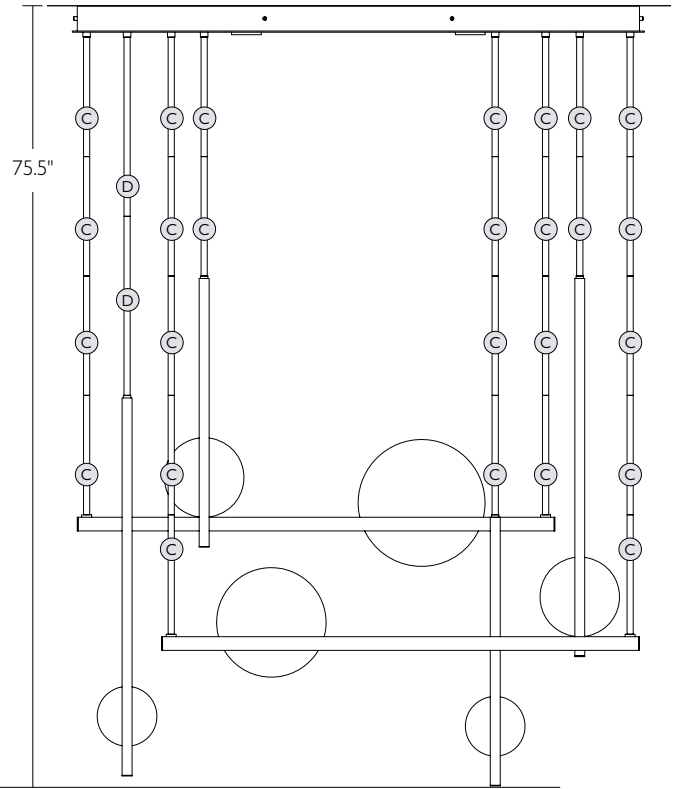

60"